

CALL 877-799-LIFT

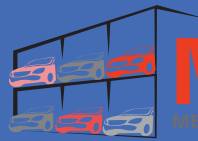

**MASS Park**  
MECHANIZED AUTO STORAGE SOLUTIONS

RAISING YOUR EXPECTATIONS

WWW.MASSPARKTLS.COM

PARK MAGIC  
TLSP1P0602R1  
PARK MAGIC PLUS  
TSP1PR0602R1

**STORAGE SPACE INTEGRATION**

6,000 LB. (2.7T) CAPACITY SINGLE POST RAMP STYLE

**2 MODELS** TO CHOOSE FROM - OPEN OR CLOSED RAMP

**“PARK MAGIC” STACKER - NO PULLEYS OR CABLES**

6,000 LB. (2.7T) CAPACITY  
**PARK MAGIC**



TLSP1P0602R1

**PARK MAGIC “PLUS”**



TLSP1PR0602R1

**PARK MAGIC**

**PARK MAGIC  
“PLUS”**



**LESS SPACE  
LESS MAINTENANCE**

PREMIUM NORTH AMERICA MADE BUCHER  
POWER UNIT - 220V OR 110V



110V 1 PH 60HZ 15 AMP

220V POWER UNITS  
USE LESS POWER LIFT  
FASTER THAN 110V.  
THE 110V VERSION  
CAN BE USED WITH  
MOST 15 AMP HOME  
CURCUITS



220V 1 PH 60HZ 11 AMP

CONTACT US NOW [WWW.MASSPARKTLS.COM](http://WWW.MASSPARKTLS.COM) OR CALL 877-799-LIFT

# 1 POST STORAGE LIFT

6,000 LB. (2.7T) CAPACITY OPEN RUNWAYS OR FULL DECK

PARK MAGIC  
TLSP1P0602R1  
PARK MAGIC PLUS  
TSP1PR0602R1

## FEATURES

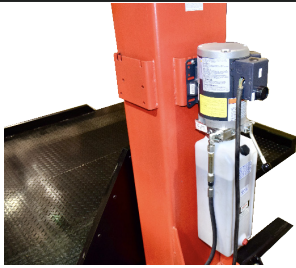

3 POWER UNIT MOUNTING BASKETS - FRONT & SIDES OF COLUMN

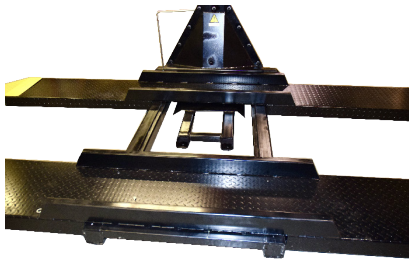

RUNWAY RUB RAILS PREVENT DRIVING OFF PLATFORMS WHEN

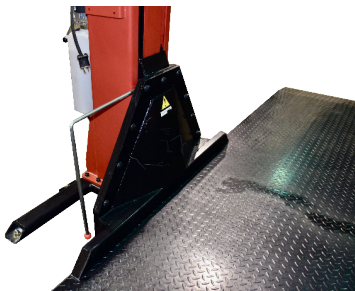

SINGLE POINT 17 POSITION MECHANICAL LOCK RELEASE

## EXPANDING YOUR PARKING OPPORTUNITIES

**PARK MAGIC** SINGLE POST STORAGE DRIVE ON LIFT  
6,000LB (2.7T)

MEETS CONSTRUCTION AND TESTING REQUIREMENTS FOR RESIDENTIAL STORAGE LIFTS. THE PARK MAGIC SERIES IS THE ULTIMATE LIFT FOR THOSE WHO WANT DEPENDABILITY WITH A MINIMUM OF MAINTENANCE



STRONG TUBULAR 59" (1500MM) STEEL FLOOR OUTRIGGER BARS ADD STABILITY



WEDGE ANCHORS & SHIMS INCLUDED WITH LIFT



LARGE REINFORCED PLATFORM - NO DRIP PROTECTION REQUIRED. PREMIUM DOUBLE BAKE POWDER FINISH RESISTS CORROSION

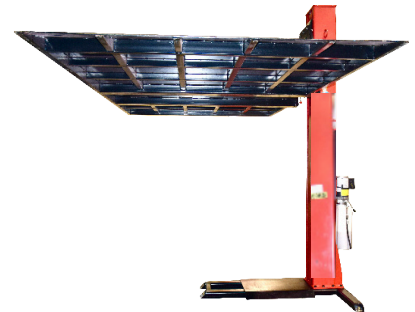

78.7" (2000MM) CLEARANCE UNDER DECK IS IDEAL FOR TRUCKS & SUVs

## NON CAR STORAGE

### "PARK MAGIC" - PARK YOUR CARS OR STORE YOUR TOYS

THE PARK MAGIC STORAGE LIFT DOUBLES YOUR GARAGE FLOOR STORAGE CAPABILITY WHEN



CONTACT US NOW [WWW.MASSPARKTLS.COM](http://WWW.MASSPARKTLS.COM) OR CALL 877-799-LIFT

# 1 POST STORAGE LIFT

6,000 LB. (2.7T) CAPACITY OPEN RUNWAYS OR FULL DECK

PARK MAGIC  
TLSP1P0602R1  
PARK MAGIC PLUS  
TSP1PR0602R1

## FEATURES

6,000LB. (2.7T) CAPACITY DRIVE ON RAMP WITH OPEN CENTER AREA



TWO (2) MODELS TO CHOOSE FROM

ONE SIZE DOESN'T FIT ALL



6,000LB. (2.7T) CAPACITY WITH COMPLETE ONE PIECE PLATFORM



### PARK MAGIC

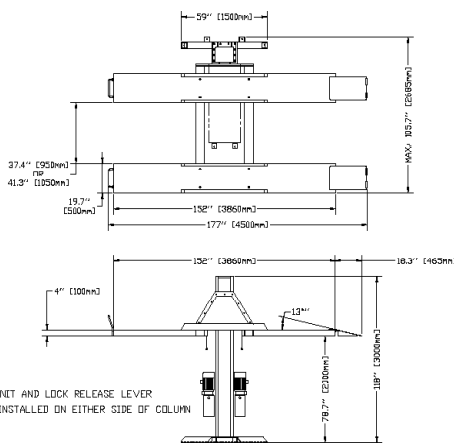

### PARK MAGIC PLUS

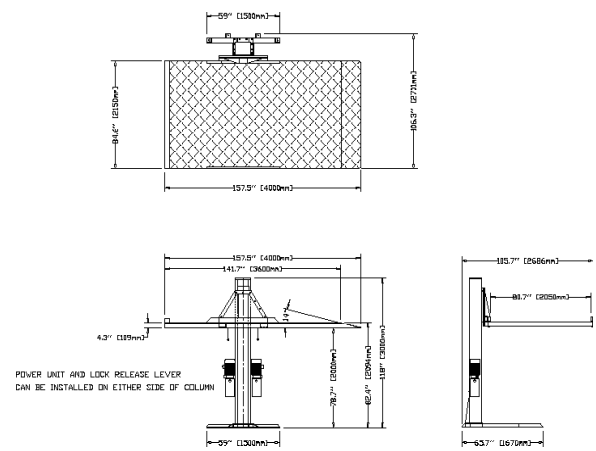

REFER TO THE SPECIFICATION CHART ON THE NEXT PAGE

- **LOW MAINTENANCE PROBLEM FREE DESIGN** - 52" (1321MM) LONG STROKE 3" (76MM) OD HIGH PRESSURE CYLINDER WITH HD LEAF CHAIN. TOUGH WHEEL-A BRATOR FINISHED STEEL STRUCTURE WITH PREMIUM DOUBLE BAKE FINISH. LOW MAINTENANCE DESIGN ELIMINATES ALL PULLEYS AND LIFTING CABLES. FEWER MOVING PARTS MEANS LESS MAINTENANCE AND SERVICE ISSUES.
- **REDUNDANT SAFETY SYSTEMS**- 17 POSITION SELF ACTIVATING MECHANICAL LOCKING SYSTEM WITH EASY TO USE RELEASE HANDLE. VELOCITY FUSED TO PROTECT AGAINST FLUID BURST. LARGE "H" SHAPED DECK STRUCTURE COMBINED WITH REINFORCED COLUMN AND BASE PROVIDE EXCELLENT STABILITY.
- **LIFTS HIGHER TO PROVIDE MORE UNDER CAR WORK AREA** - LIFTS 78.7" / " (2000 MM) UNDER LIFTING BOLSTER (WHEN SITTING ON THE TOP LOCK).

**COMPACT SPACE SAVING DESIGN** - LIFT VEHICLES IN BUILDINGS WITH CEILINGS AS LOW AS 10' (3048MM) . DESIGNED TO FIT MOST STANDARD GARAGE LAYOUTS WITH A COMPACT

- **ACCOMODATES MOSTS CARS** - DRIVE ON BACK OFF RUNWAYS 19.7" (500MM) WIDE X 152" (3860 MM) LONG. BUILT IN FOOTPRINT. RUB RAILS PREVENT VEHICLES FROM DRIVING OFF RUNWAYS. REMOVABLE FRONT WHEEL STOPS.
- **FLEXIBLE VEHICLE LOADING** - LOW TO THE FLOOR 4.5" / 114 MM LOWERED CLEARANCE HEIGHT. STRONG STABLE BASE FRAME PROVIDES STABILITY WHEN FULLY LOADED.
- **PREMIUM NORTH AMERICAN COMPONENTS** - NORTH AMERICAN MADE MONARCH (BUCHER) POWERUNIT, 110V 15 AMP 1HP .75KW OR 2HP/1.5KW 220V 11 AMP 60HZ LIFTS TO FULL HEIGHT IN 45 SECONDS.



### MASS PARK BY TLS

HEAD OFFICE & MANUFACTURING CENTRE  
2300 SPEERS ROAD, OAKVILLE ONTARIO, L6L2X8  
CALL: 866-799-5438 FAX: 905-891-1214

MASS PARK AND ALL IT'S REGISTERED TRADE MARKS ARE PART OF THE TLS LIFT GROUP. PLEASE CALL US FOR PRODUCT INFORMATION ON COMMERCIAL AND HEAVY DUTY LIFT PRODUCTS. WWW.TLSLIFTS.COM



# 1 POST STORAGE LIFT

6,000 LB. (2.7T) CAPACITY OPEN RUNWAYS OR  
FULL DECK

PARK MAGIC -  
TLSP1P0602R1  
PARK MAGIC PLUS -  
TSP1PR0602R1

## TECHNICAL SPECIFICATIONS

MODEL NUMBER	TLSP1P0602R1	TLSP1PR0602R1
FEATURE	<b>OPEN RUNWAYS</b>	<b>FULL DECK</b>
CAPACITY	6,000 LBS / 2.7T	6,000 LBS / 2.7T
OVERALL LENGTH WITH RAMPS	177" (4500MM)	157.5" ((4000MM)
RUNWAY LENGTH	152" (3860MM)	141.7" (3600MM)
DRIVE ON APPROACH ANGLE	13 DEGREES	14 DEGREES
WIDTH OF BASE WITH OUTRIGGERS	59" (1500MM)	59" (1500MM)
APPROACH RAMP LENGTH	18.3" (465MM)	15.8" (401MM)
WIDTH BETWEEN RUNWAYS	37.4" OR 41.3" (950 OR 1050MM)	N/A
RUNWAY/DECK WIDTH (INCLUDES RUB RAILS)	19.7" (500MM)	84.6" (2150MM)
WIDTH OUTSIDE RUNWAYS	76.4" OR 80.7" (1941 OR 2050MM)	N/A
OVERALL WIDTH (NO POWER UNIT)	105.7" (2685MM)	106.3" (2701MM)
COLUMN HEIGHT	118" (3000MM)	118" (3000MM)
RUNWAY HEIGHT	4-1/2" (114MM)	3 1/2" (119MM)
LIFTING HEIGHT	82.4" (2093MM)	82.4" (2093MM)
MAX. CLEARANCE (UNDER RUNWAY)	78.7" (2000MM)	78.7" (2000MM)
POWER SUPPLY	110V 15 AMP 1HP .75KW 220V 8 AMP 2HP 1.5KW	110V 15 AMP 1HP .75KW 220V 8 AMP 2HP 1.5KW
PUMP & MOTOR LOCATION	FRONT, BACK OR SIDE OF COLUMN	FRONT, BACK OR SIDE OF COLUMN
MECHANICAL LOCKING SYSTEM	SINGLE POINT LOCK RELEASE WITH 17 LOCK POSITONS	SINGLE POINT LOCK RELEASE WITH 17 LOCK POSITONS
SHIPPING WEIGHT	2250 LB. / 1023KG	2650 LB. / 1205 KG
CONCRETE REQUIRED	6" (152.4MM)	6" (152.4MM)

**Disclaimer: Mass Park is constantly updating their products to maintain the highest possible standards of performance and safety. The specifications included in this brochure are only accurate at the time of printing and are subject to change without notice.**



### MASS PARK BY TLS

HEAD OFFICE & MANUFACTURING CENTRE  
2300 SPEERS ROAD, OAKVILLE ONTARIO, L6L2X8  
CALL: 866-799-5438 FAX: 905-891-1214

MASS PARK AND ALL IT'S REGISTERED TRADE MARKS  
ARE PART OF THE TLS LIFT GROUP. PLEASE CALL US  
FOR PRODUCT INFORMATION ON COMMERCIAL AND  
HEAVY DUTY LIFT PRODUCTS. WWW.TLSLIFTS.COM

